

# C&I PV System Safety White Paper

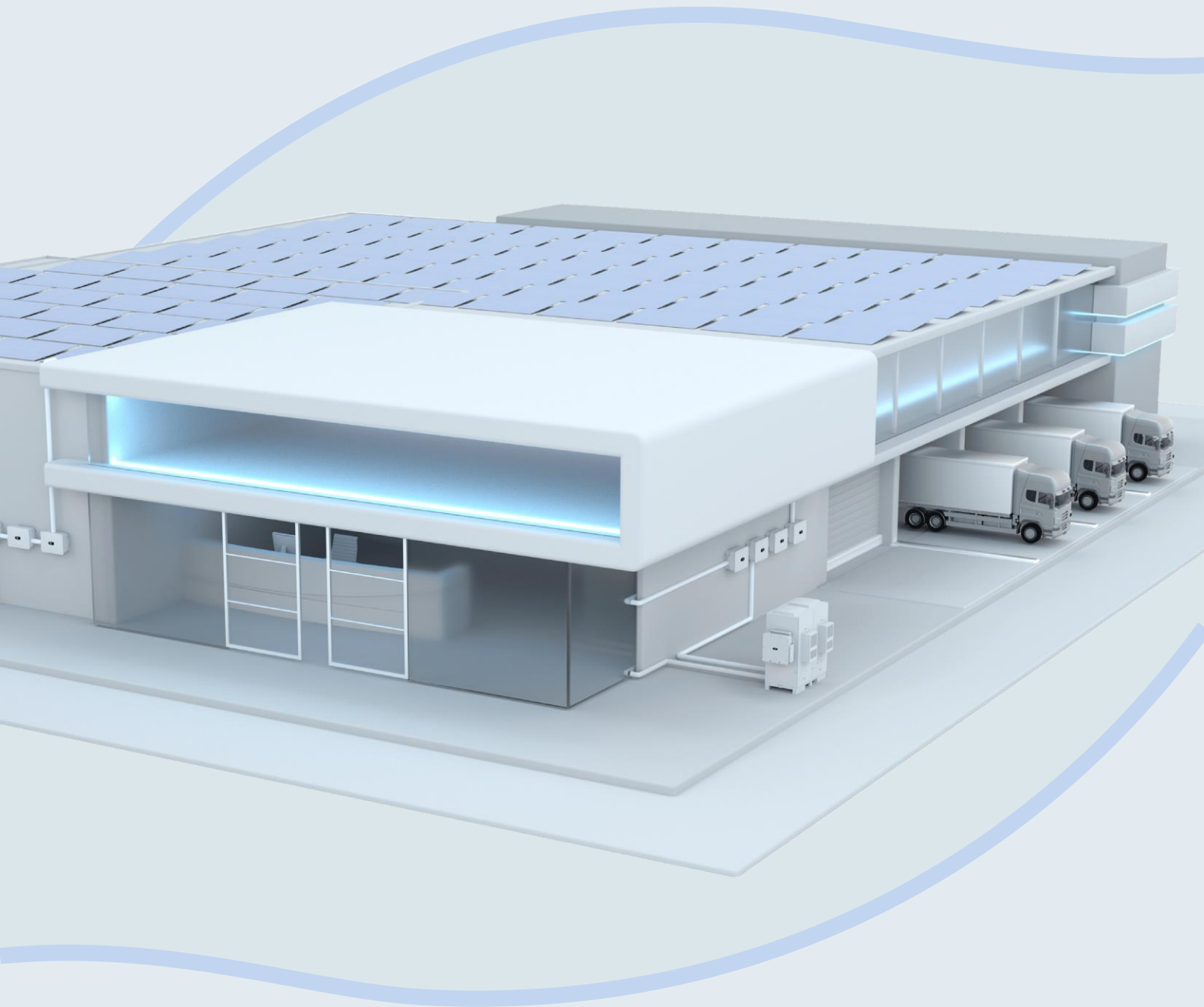

# Introduction

---

Developing renewable energy and improving energy consumption structure are effective ways to address environmental and climate issues. Therefore, the EU has presented "REPowerEU", a green plan that requires EU member states to invest EUR565 billion in infrastructure by 2030. In September 2020, China proposed the "dual carbon goals", that is, achieving carbon peak by 2030 and carbon neutrality by 2060. In addition, soaring electricity prices in Europe and increasingly large price differences between peak and off-peak hours in many regions also drive enterprises to start green transformation, obtain lower levelized cost of electricity (LCOE), and achieve sustainable business operations. With policy factors and cost reduction, it is now the best time to develop green power.

However, compared with traditional power generation, the still young photovoltaics (PV) industry is faced with various technical challenges, especially for commercial and industrial (C&I) PV projects, most of which are located in industrial and residential areas in the vicinity of power users. Once an accident occurs, it poses serious threats to the personal and asset safety.

To provide the industry with comprehensive insights into the PV safety protection technologies, Huawei and CER, UIU jointly present this White Paper, which describes the safety challenges, solutions, evaluation of existing solutions and technologies, and application prospects in C&I PV systems.

This White Paper highlights the importance of safety designs for PV system construction and provides guidance for future PV system safety solutions. ■



# Contents

---

## 01 /

### Status of Development of C&I PV System

1. Increasing Installed Capacity
2. High-Power PV Modules
3. Complex and Various Application Scenarios

## 02 /

### PV System Safety Challenges

1. Device Safety Risks from DC Faults
2. Asset Safety Risks from DC Arc Fires
3. Personal Safety Risks from High Voltage or Exposed Conductors
4. Summary

## 03 /

### FusionSolar C&I PV Safety Solution

1. System-Level Device, Asset, and Personal Safety Design
2. Active Shutdown for Device Safety
3. Active Arc Extinction for Asset Safety
4. Safe Voltage Control for Personal Safety
5. Summary

## 04 /

### FusionSolar C&I PV Safety Test

1. Function Tests
2. Summary

## 05 /

### Summary and Prospects





## 1.1 Increasing Installed Capacity

---

The PV industry is developing rapidly thanks to favorable policies and economic factors. According to statistics, the global cumulative solar photovoltaic capacity has grown continuously from 1.25 GW since 2000. In 2023, global cumulative solar PV capacity amounted to 1,624 gigawatts, with roughly 447 gigawatts of new PV capacity installed in that same year. In Bangladesh, as of December 2023, the combined rooftop solar capacity installed under net-metered and non-net-metered systems reached 162.73 megawatts(MW). According to a research report

released by the United States Department of Energy, PV power generation will account for 40% of the power supply in the United States by 2035. Indonesia plans to add 4.7 GW installed PV capacity by 2030. Australia plans to install 8.9 GW by 2025 on the basis of the existing 14 GW. By 2025, the newly installed PV capacity in China will reach 110 GW, an increase of 128.22% compared with 2020. The following figure shows the global installed capacity of C&I PV from 2020 to 2025. The rapid growth indicates that C&I PV is poised to become the main growth point of the PV industry in the future. ■

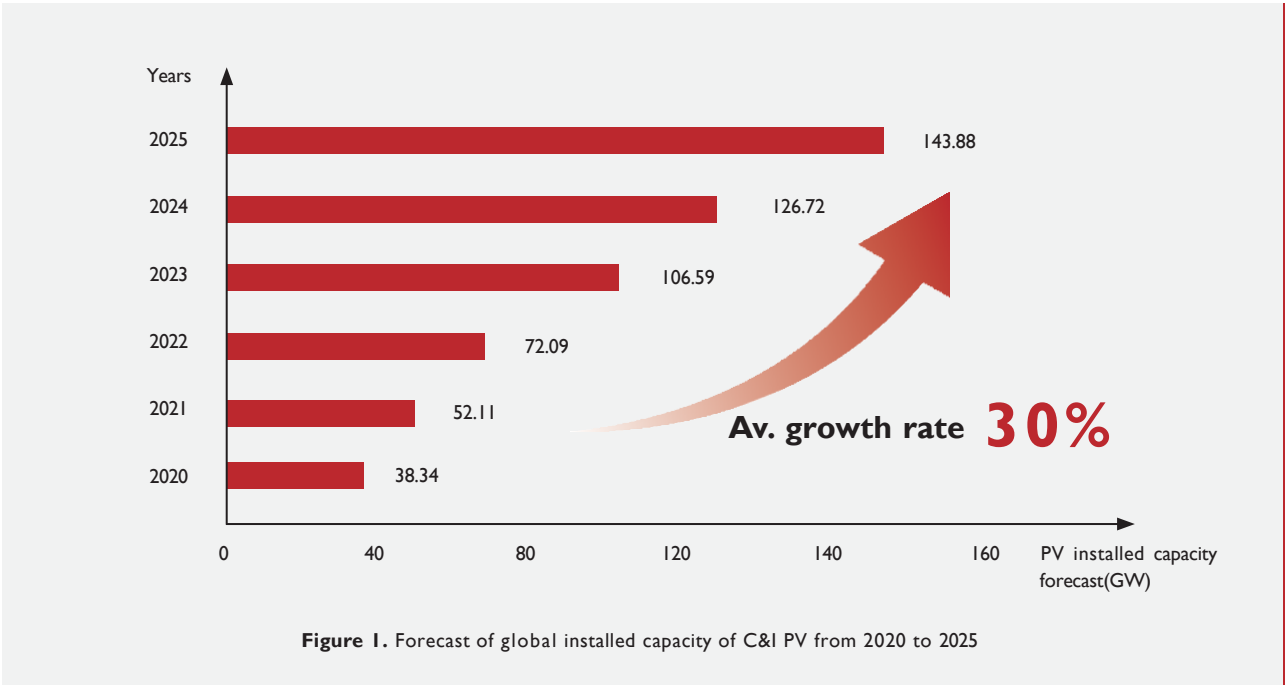

## 1.2 High-Power PV Modules

The development of PV modules can be divided into three phases. The first phase is from 1981 to 2012, with 100 mm and 125 mm as the common choices. The second phase is from 2013 to 2018, when 156 mm and 156.75 mm are popular. The third phase is after 2018, with 158.75 mm, 160 mm, 161.7 mm, 166 mm, 182 mm and 210 mm as the mainstream. Large size means high production of silicon wafer, batteries, and PV modules, thereby reducing the cost per watt. In addition, large-sized silicon wafer can effectively im-

prove the PV module power and improve the PV module efficiency with optimized battery and PV module design. Furthermore, as power and efficiency of a PV module increase, using large-sized silicon wafers can reduce costs of supports, combiner boxes, cables, land, etc, further reducing the cost per watt. According to the China Photovoltaic Industry Association's statistics, the market share of PV modules by size from 2019 to 2025, 182 mm and 210 mm PV modules will become the mainstream in the future PV market. ■

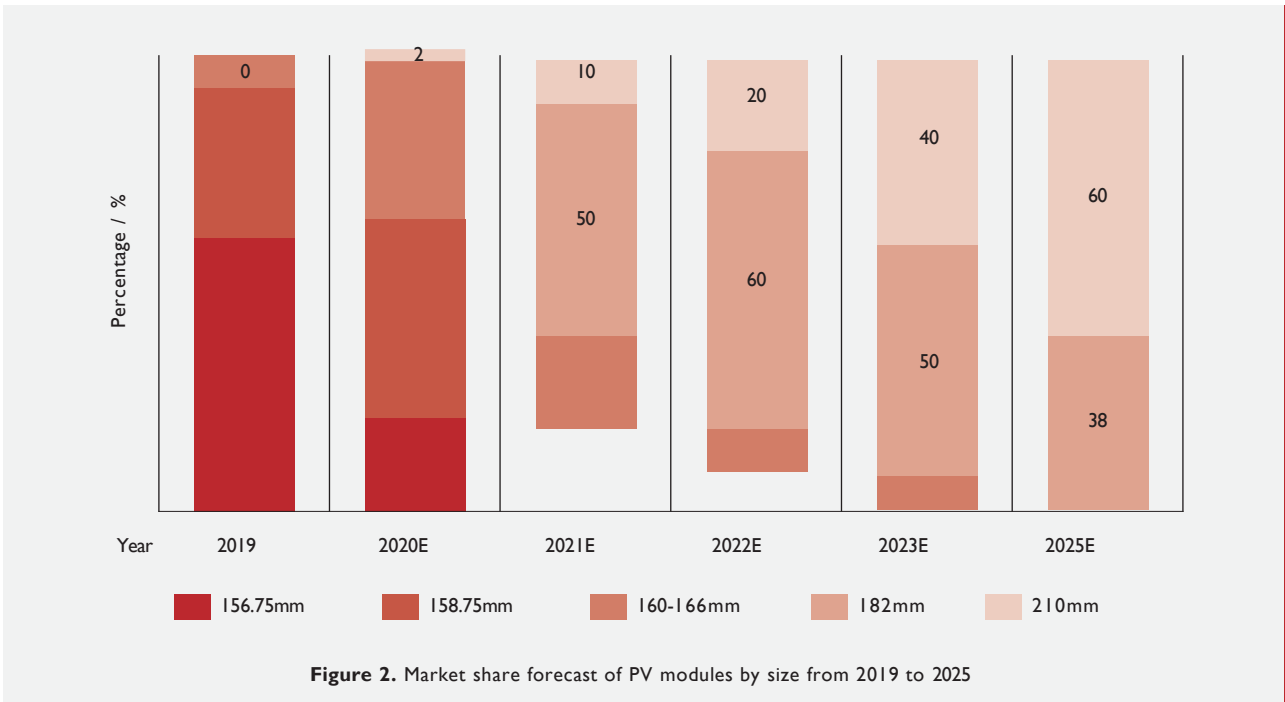

### 1.3 Complex and Various Application Scenarios

C&I PV is closely related to buildings, and rooftop PV plants are the common type. Currently, the building integrated photovoltaics (BIPV) is also developing, which is the integration of PV into the building envelope, such as solar tiles, curtain walls, and skylights. The projects take on various distributed "PV+" forms, including PV+factory, PV+port, PV+logistics, and PV+shopping malls/supermarkets. PV rooftops and C&I buildings are integrated to facilitate people's production and life. ■



Figure 3. C&I PV application scenarios



## 2.1 Device Safety Risks from DC Faults

As mentioned above, high-power PV modules (182 mm and 210 mm) have become the mainstream in the market, and the DC power and current of PV systems keep increasing. Despite its lower costs, high-power PV modules pose higher safety risks in the case of DC faults. When a fault occurs, the short-circuit current generated at the fault point increases accordingly. According to Joule's Law  $Q = I^2 \times R \times T$ , if the current doubles, the heat at the short-circuit point increases by four times, and the risk of fire increases greatly.

According to statistics, 74% of inverter failures are caused by DC faults (based on Huawei 175 GW running statistics). For a grounded PV system, DC faults can be classified into line-to-line faults and grounding

faults. PV string reverse connection, DC input back-feed, overvoltage, and inverter internal short circuit are common DC line-to-line faults. In a PV system, multiple PV strings are connected in parallel to the input side of the PV system. When one or more PV strings are reversely connected, the PV string with the correct polarity injects current into the PV string with the reverse polarity. If the current cannot be disconnected in time and exceeds the limit that PV modules can withstand, PV modules will be damaged or even burned, causing fire risks. The DC bus short-circuit is an internal fault of the inverter. If the inverter cannot disconnect the DC input energy, a large amount of energy will accumulate at the fault point, which severely

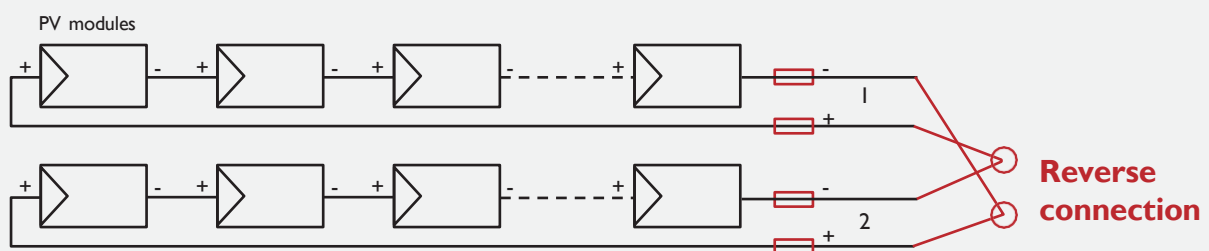

Figure 4. Current backfeed on the DC side



Burned DC cables



Damaged Bus capacitor

**Figure 5.** Common DC line-to-line faults

threatens the safety of cables and equipment and may even cause fire.

A grounding fault refers to a low resistance between a point on the DC side and the ground (generally, the potential of the ground is 0). That is, the point is directly connected to the ground through a conducting wire, which is called a short circuit between the point and the ground. In a PV system, the main cause of short circuit to the ground is that the internal conductor is exposed due to cable damage. The grounding fault is a serious DC fault. It will generate hundreds or thousands of amperes of current in the circuit. If the current cannot be disconnected in time, a large amount of heat will be generated and the equipment will be damaged.

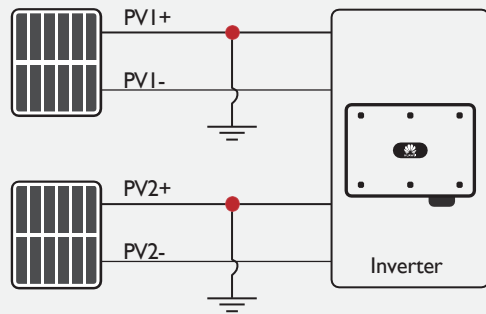

**Figure 6.** Common DC side faults

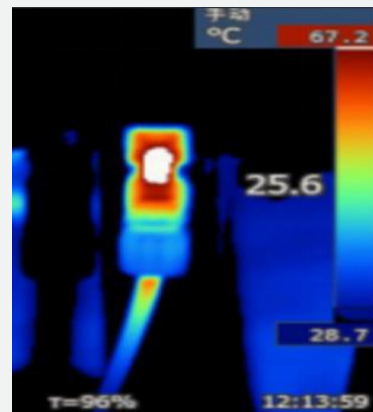

**Figure 7.** PV terminal faults



The generated arcs will melt many components in a short time. In addition, the current brings electromagnetic force, which may damage the equipment.

In addition to line-to-line faults and grounding faults, terminal faults, such as short circuits, overcurrent, and loose connection caused by improper cable connection operations, land subsidence, aging compo-

nents, and loose contacts, are also common DC faults. A fault caused by a high current is accompanied by a temperature increase. Therefore, a terminal fault is often accompanied by a terminal overtemperature, which is similar to the preceding faults. If the current cannot be disconnected in time, the terminal will be burned or even cause a fire. ■

## 2.2 Asset Safety Risks from DC Arc Fires

As discussed earlier, C&I PV are developing toward complex and various application scenarios. The integration of PV and C&I buildings helps business owners reduce electricity costs and carbon emissions, but also brings higher safety risks. C&I PV systems are mainly installed on the power user side. Safety accidents not only endanger the system itself, but also affect the surrounding environment and buildings, causing asset losses or even personal injury.

Among all kinds of PV system safety accidents around the world, electrical fire is the most frequent PV safety accident that causes the greatest losses. According to the research by Mannheimer Versicherung, a famous German insurance company, the compensation amount for PV plant fire accidents accounts for 32% of

the total amount in a year, ranking No. 1 in the company's claim payouts.

Statistics show that more than 60% of PV plant fire accidents are caused by DC arcs. Loose or poor contacts, broken or damp cables, aging or damaged insulation materials, carbonization, and corrosion may cause arcs. In a PV system, there are many wiring terminals on the DC side. Apart from other insulated parts, a MW-level PV plant contains thousands of contact points, and there is a high probability that electric arcs occur. If the DC arcs cannot be rapidly interrupted, they will cause an electrical fire, resulting in huge asset losses or even threatening personal safety. Therefore, the active and rapid shutdown is the key to ensure the asset safety of C&I PV systems. ■

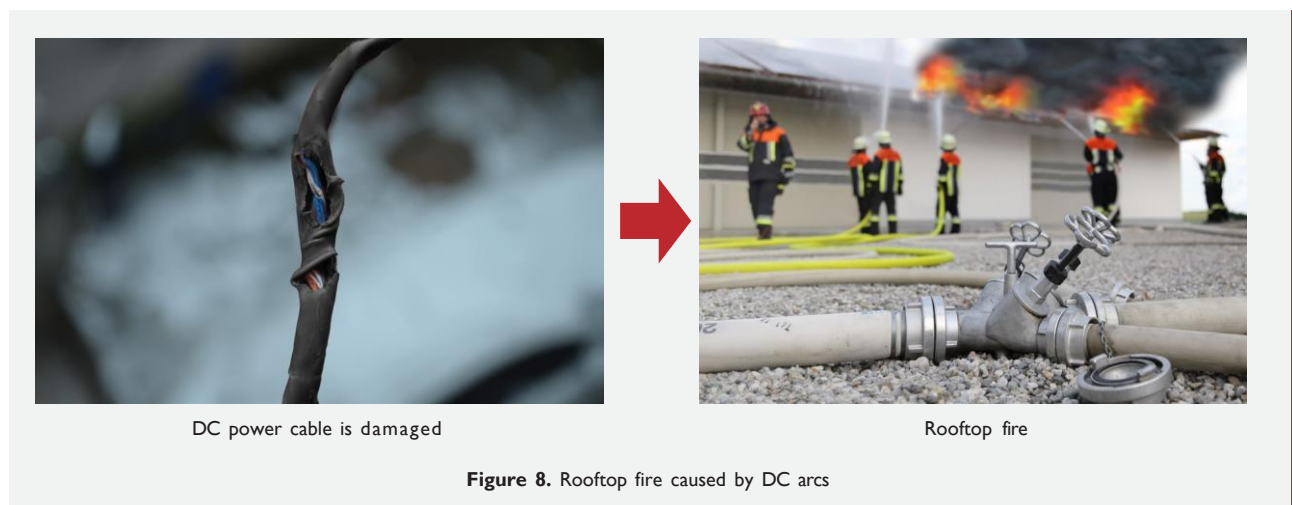

## 2.3 Personal Safety Risks from High Voltage or Exposed Conductors

As previously stated, an electrical fire is a safety accident that causes the greatest losses to a PV system. When a fire or other emergency occurs on a rooftop PV plant, firefighters need to go to the site for fire fighting. However, for a rooftop PV plant, PV modules will continue to be energized, and the PV module output can-

not be disconnected even if the inverter is shut down. This means that after a fire occurs, the system still generates a high voltage of hundreds or even thousands of volts. If firefighters initiate a rescue in this scenario, they will be exposed to critical risks. Therefore, the PV module voltage needs to be quickly disconnected to be-



Figure 9. High voltage on the rooftop



Cables tied to a support

Loosely connected connectors

Cables under long-term stress

Damaged cable sheath

Figure 10. Common insulation resistance faults

low the safe voltage. In this way, the personal safety of firefighters can be protected and firefighters can safely go to the rooftop for fire rescue.

In addition to the high voltage on the rooftop, there are some electric shock risks that can be easily ignored in a PV system, for example, electric shock risks caused by reduced insulation resistance of the system. The insulation resistance indicates the integrity of insulation materials. If PV modules, DC cables, or connectors are damaged or the insulation layer is aged, the insulation resistance will be low. In other words, if the insulation resistance of the system decreases, the insulation layer is damaged. As a result, the conductor inside the cable is exposed and electric leakage occurs in the system, causing electric shocks and threatening personal safety of the O&M personnel. ■

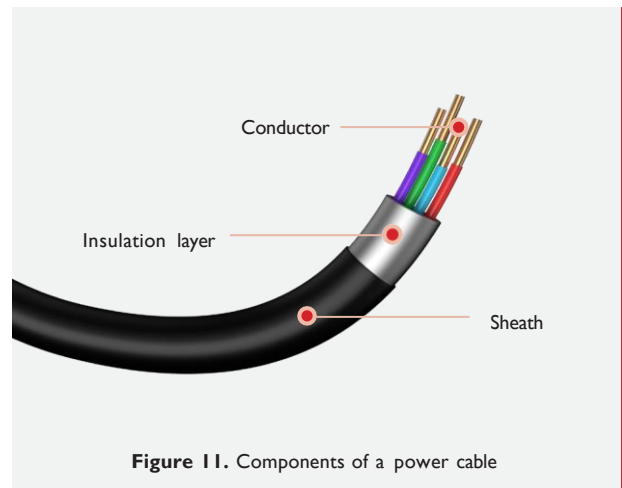

Figure 11. Components of a power cable

## 2.4 Summary

---

A PV system involves various safety risks to PV equipment, asset in surrounding environments, and personal safety of O&M and firefighting personnel. With the popularization of high-power PV modules, DC faults bring higher equipment risks. Moreover, as C&I PV systems are mainly distributed on the consumption side, fires caused by electric arcs affect the PV system itself as well as the surrounding environments, threatening the asset safety of owners. High voltage on the rooftop and exposed cable conductors may also cause electric shocks to firefighters and O&M personnel when they visit the site for fire fighting or O&M. Therefore, the safety design of a PV plant needs to consider the equipment, asset, and personal safety. A systematic solution design is required to build a truly safe and reliable PV plant. ■



To address the preceding safety challenges, the industry has developed some solutions. However, traditional solutions have only partial safety measures

but not designed at the system level and have many technical challenges, which cannot meet the increasingly high safety requirements of PV systems. ■

### 3.1

## System-Level Device, Asset, and Personal Safety Design

---

The C&I safety solution provided by Huawei is designed from three aspects: equipment, asset, and personal safety with industry-leading technologies to achieve zero risks in PV plants.

#### Device safety

Huawei's Smart String-Level Disconnect (SSLD) technology, grounding protection of PV cables, and terminal overtemperature detection actively disconnect DC high current and voltage and eliminate DC faults.

#### Asset safety

Huawei's smart DC arc detection and rapid shutdown (with AFCI) technologies actively and rapidly extinguishes arcs and prevents fires.

#### Personal safety

Huawei's module-level rapid shutdown (RSD) technology and module-level insulation impedance fault location technologies disconnect high voltage.

## 3.2 Active Shutdown for Device Safety

As high-power PV modules become the mainstream in the market, safety risks caused by DC faults are increasingly prominent. It is crucial to actively dis-

connect current and voltage in the case of line-to-line faults (reverse connection, current backfeed, and bus short circuit), grounding faults, or terminal faults. ■

### 3.2.1 | Smart String-Level Disconnect (SSLD)

In case of common line-to-line faults such as PV string reverse connection, backfeed, and bus short circuit, the industry typically uses a DC disconnecter between the PV string and inverter, which requires manual operation to turn on and off the disconnecter because it cannot work automatically. In addition, when a fault occurs in the inverter or PV string, the DC disconnecter cannot stop the short-circuit current, which may cause fire risks.

To tackle this problem, Huawei launches the SSLD solution for the C&I scenarios. The inverter can detect the voltage and current signals of each PV string, key signals inside the inverter, as well as status signals of the SSLD device in real time. After collecting the signals, the inverter uses Huawei's advanced intelligent algorithms to determine whether a fault occurs and the fault type. When the inverter detects a fault in the

system and requires the disconnecter to be turned off, the main control chip sends a turn-off signal to the SSLD device. After the SSLD device receives the signal, it automatically executes the command. After the SSLD device is turned off, the main control chip can detect whether the disconnection is complete. If an exception occurs, the inverter activates an exception handling mechanism to ensure the high current is cut off to protect equipment.

To sum up, Huawei SSLD solution adopts digital technologies to actively send a turn-off signal to the DC SSLD device to quickly trigger tripping and active alarms. After that, the current is cut off in milliseconds, effectively protecting the system from faults, such as PV string reverse connection, current backfeed, and DC bus short circuit. This achieves active safety protection for the PV system instead of passive safety. ■

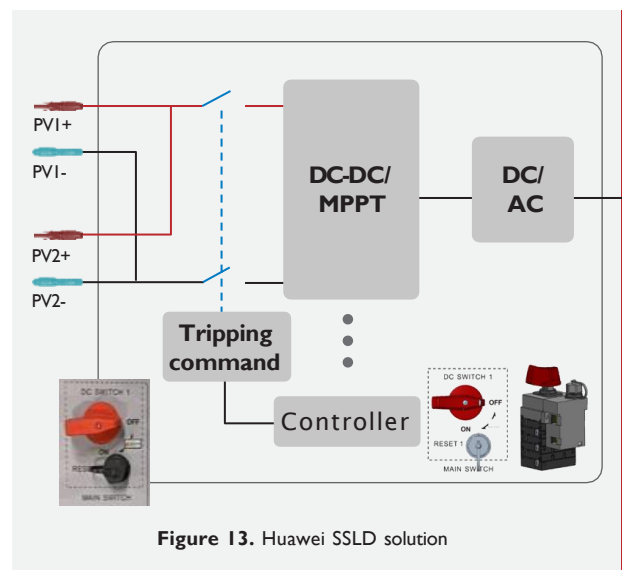
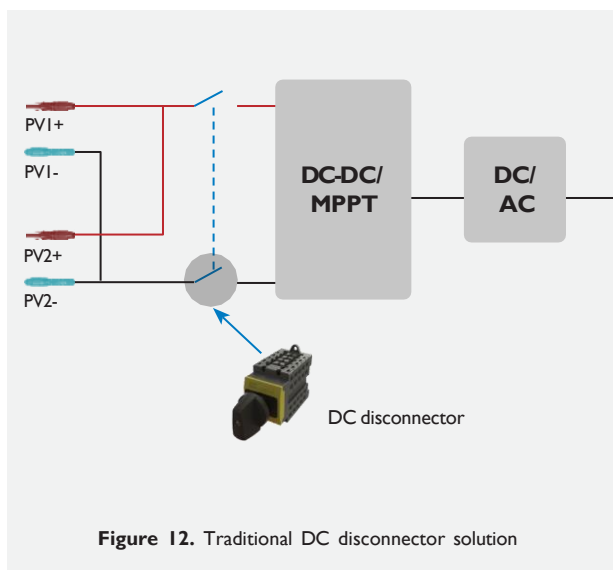

### 3.2.2 | PV Ground-Fault Protection

Grounding fault is a type of serious DC faults. Once PV cables are grounded to form a loop, local overheating, electric sparks, or even fires may occur. However, few technical solutions can be found in the industry. To solve this problem, Huawei inverters detect the phase voltage and current to identify whether

PV modules are short-circuited to the ground. If a fault is detected, the inverter shuts down immediately, turns off the grid connection switch, generates an alarm to protect the inverter from damage, and reports the alarm to the app. ■

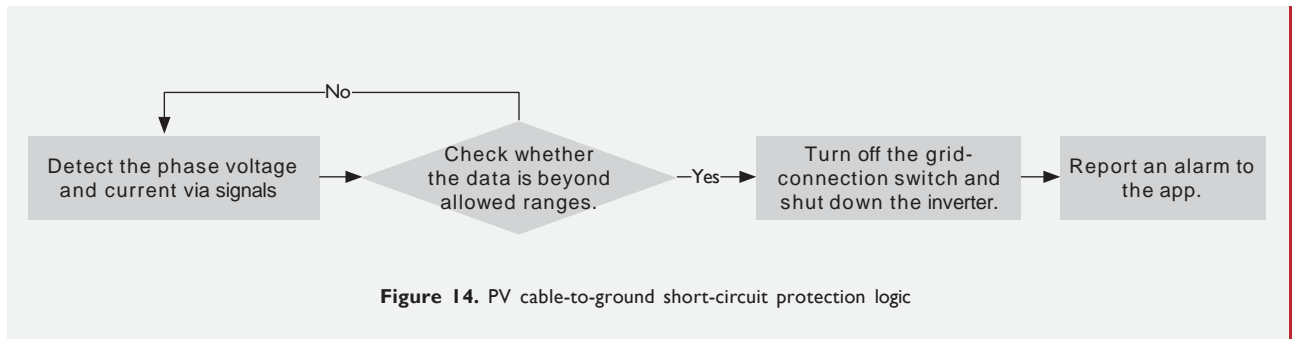

### 3.2.3 | Smart Connector Temperature Detector (SCTD)

Many risks may occur on the DC side of the PV system. In traditional solutions, terminals are connected through cables without any overtemperature detection. As a result, terminals will be easily burned.

Huawei perfectly overcomes this challenge by developing the industry's first intelligent terminal overtemperature detection technology (SCLD-TECH) for C&I scenarios. An NTC temperature detection circuit is deployed near the PV terminals to sample the temperature of PV terminals via voltage signals which will change according to the terminal temperature change and be received by the data signal processor (DSP). When detecting that the terminal temperature is high, the inverter enables the protection mechanism, generates an alarm, and reports the alarm to the app to prevent the fault from spreading. ■

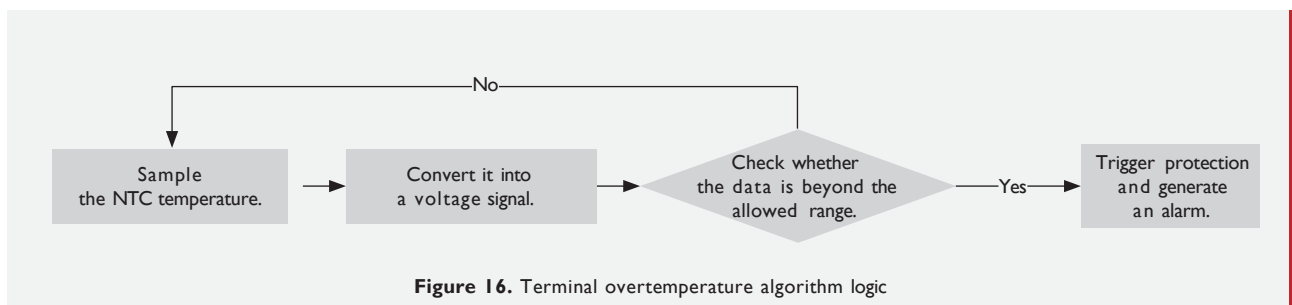
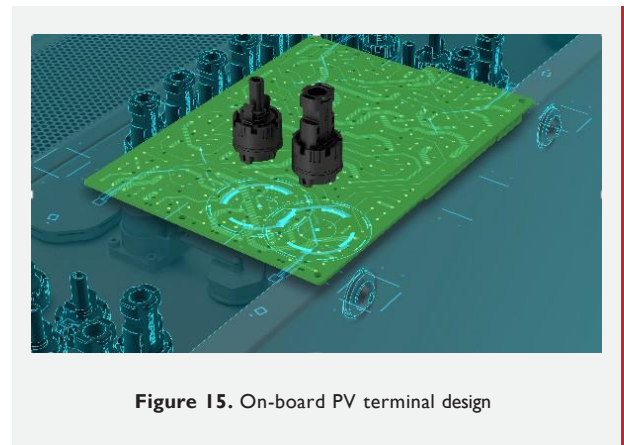

# 3.3 Active Arc Extinction for Asset Safety

As mentioned earlier, electrical fire caused by DC arcs is the most common safety accident with the greatest losses in PV systems, which seriously threatens the asset safety of owners. The key solution is to realize active and rapid shutdown in case of DC arcs. ■

## 3.3.1 | Arc-fault Circuit Interrupter Design (AFCI)

An arc is a glow phenomenon caused by the ionization of the air when an electric conductor is close to another conductor (or ground) and the voltage between them breaks down the air. An arc can produce high temperatures and even open flames. If arcs occur in an electrical system, surrounding insulating materials will break down or carbonize and lose the insulation effect, and other materials may easily reach the ignition point and catch fires.

An arc model is a time-varying nonlinear model. Similar to a noise signal, an arc signal has its energy distributed on almost all spectrums, represented by an

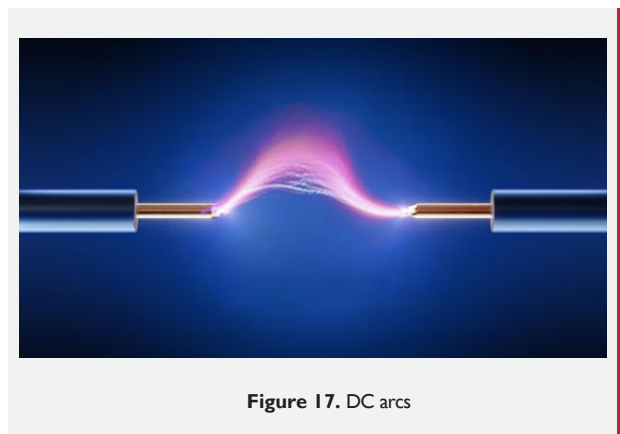

Figure 17. DC arcs

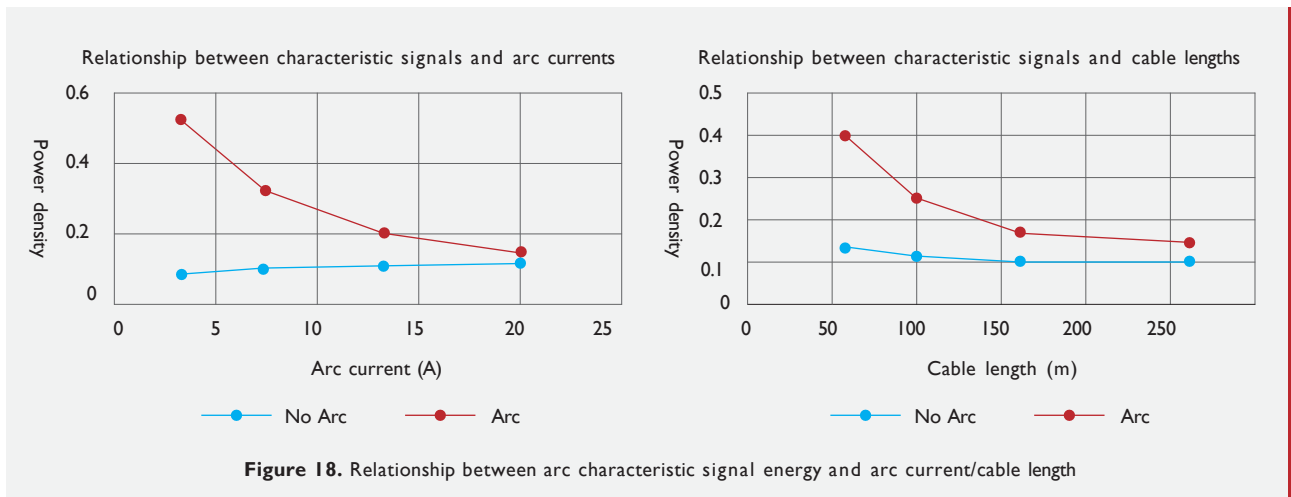

Figure 18. Relationship between arc characteristic signal energy and arc current/cable length

increase in energy of different frequency bands. Such feature enables a management system to detect any arc in a circuit according to the change of electrical parameters and spectrums. However, as the current increases, the ionization phenomenon is more stable, and the arc model is closer to the signal characteristics before the arc occurs. A longer cable indicates a larger

high-frequency impedance and a smaller arc signal. This poses a higher challenge to arc detection precision and capability.

As a matter of fact, a PV system usually operates in a complicated and changeable environment. The conventional solution performs empirical analysis and induction on arc signals while lacks the capability of

generalization. When the environment noise is close to the characteristics of an arc spectrum, it cannot be effectively distinguished, which may easily cause false protection. In addition, once an algorithm is determined in the conventional solution, the determination logic will be fixed. In this way, as the current or cable length increases, the accuracy decreases and the false positive rate increases. As a result, the detection range of the

conventional AFCI solution is only 80 m, the detected current is 16 A, and the shutdown time is 2.5s. However, with the increasing C&I scale, the 80 m detection range cannot meet the detection range requirements, the detectable current range cannot adapt to mainstream high-power PV modules, and the long shutdown time cannot meet the requirements for mission-critical scenarios.

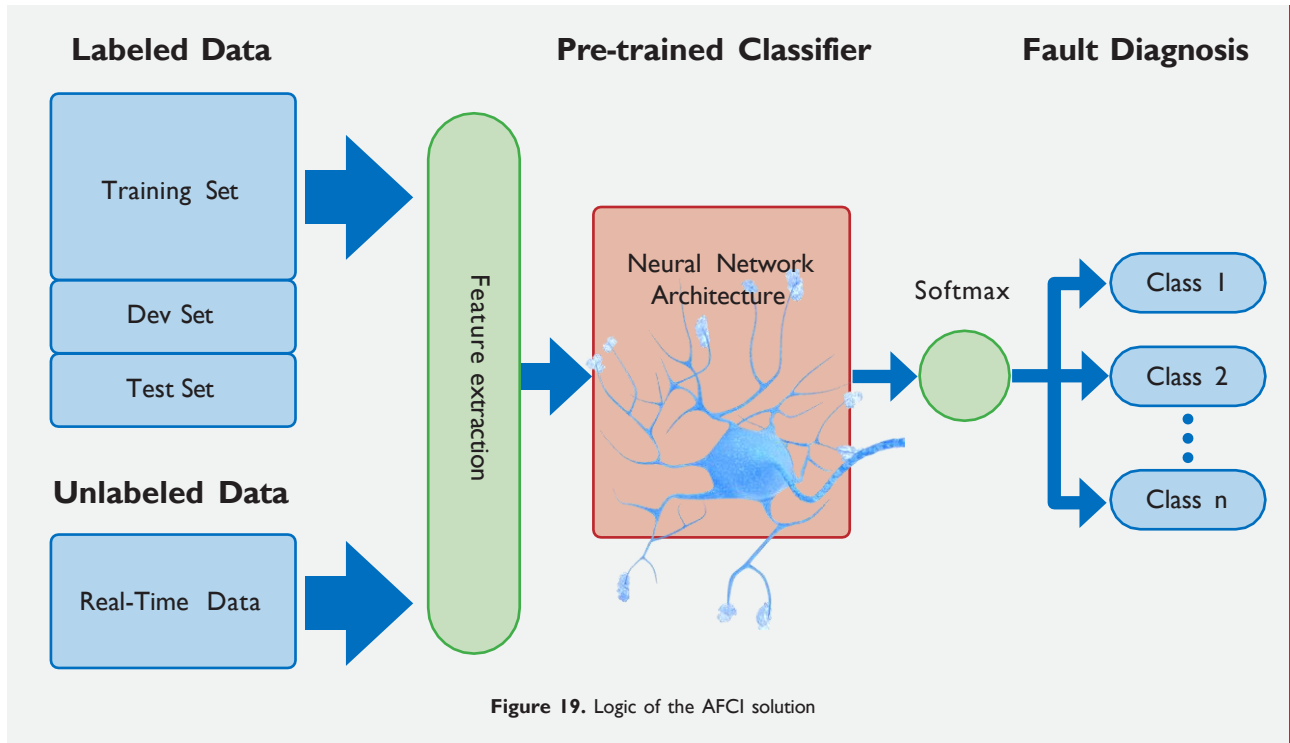

Figure 19. Logic of the AFCI solution

To solve these problems, Huawei combines AFCI with deep learning technologies based on its advantages and accumulated experience in various fields. Instead of adopting manual induction design, Huawei's solution uses intelligent algorithms to automatically search for arc characteristics. The solution also computes and iterates massive data simultaneously based on highly non-linear models to find the high-dimensional characteristics rules for effective identification of arc characteristics signals. In addition, Huawei AFCI algorithm is deeply integrated with power electronics technologies as well as the topology of inverter power to dynamically identify the cable length and adjust the algorithm

according to the cable length and current. Even if the cable length and current increase, the AFCI algorithm can maintain high accuracy.

With such an intelligent algorithm, Huawei AFCI solution supports a detection range of 200 m for inverters to detect signals in all scenarios, provides the 30 A MPPT current detection capability for inverters to work perfectly with the mainstream 182 mm and 210 mm PV modules, and achieves 0.5s arc shutdown time to minimize safety risks in some mission-critical scenarios. In addition, Huawei's AFCI solution supports the rapid shutdown function when the optimizer is used, ensuring the safety of power plants. ■



## 3.4 Safe Voltage Control for Personal Safety

Personal safety is a red line in any scenario. As mentioned earlier, high voltages or exposed conductors may cause electric shocks in a PV system. Therefore, rapid shutdown for high-voltage devices is a key to personal safety. ■

### 3.4.1 | Module-Level Rapid Shutdown

With the advancement of PV technologies, the levels of power, current, and voltage of PV products keep increasing and voltage of PV systems evolves from 600 V to more than 1000 V. The high voltage on rooftop PV systems seriously threatens the personal safety of firefighters.

Therefore, the National Electrical Code (NEC) codified the NEC 2014 690.12 Rapid Shutdown of PV Systems on Buildings in 2014 to specify strict requirements on rapid shutdown of PV systems, which refers to rapidly shutting down the connection between PV modules. According to the NEC 2017 690.12, the voltage shall be limited to below 30 V and 80 V within 30 seconds of rapid shutdown initiation for controlled conductors located outside and inside the boundary (305 mm from the array in all directions), respectively.

Against this backdrop, Huawei Smart PV solution works with a Smart Module Controller to rapidly cut off the voltage of PV modules. The connection between PV modules can be actively shut down through the app without manual site visits. In this case, the voltage of PV strings depends on the number of Smart Module Controllers and their output voltage (1 V each), which ensures personal safety. The Smart Module Controllers can reduce the system voltage to less than 30 V within 30s, better meeting the requirements of mission-critical scenarios for rapid shutdown. ■

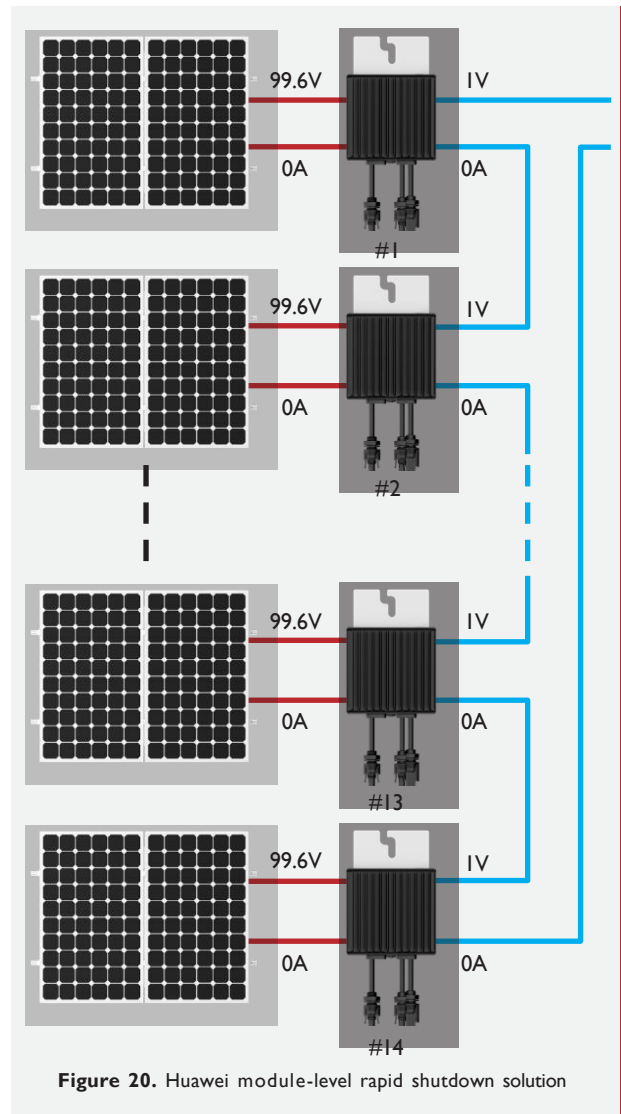

Figure 20. Huawei module-level rapid shutdown solution

### 3.4.2 | Module-level Resist Insulation Detection

In most cases, if the insulation layer of cables is damaged and the conductors are exposed, the insulation resistance of the PV system will decrease, which may cause electric shocks. The existing standards IEC 62446-1 and NB/T 32004-2013 only restrict grid con-

nection when the insulation resistance of inverters is lower than the specified value or threshold. Conventional solutions can only generate an inverter shutdown alarm in this case, instead of providing any visible warning or fault location measure. Personnel need to

inspect all PV modules connected to the inverter one by one by connecting them to the inverter independently and checking whether the inverter generates a shut-down alarm.

To save the labor, Huawei uses the built-in intelligent software algorithm of the inverter to collect statistics on the insulation resistance of the entire PV system when the PV system is grid-connected. The statistics are presented for the owner as a reference to determine potential insulation risks in the PV system based on the insulation resistance changes, and handle the risks in advance. With the help of the FusionSolar app, owners can detect the insulation resistance online. When the insulation resistance is lower than the threshold, the app generates an alarm and locates the insulation

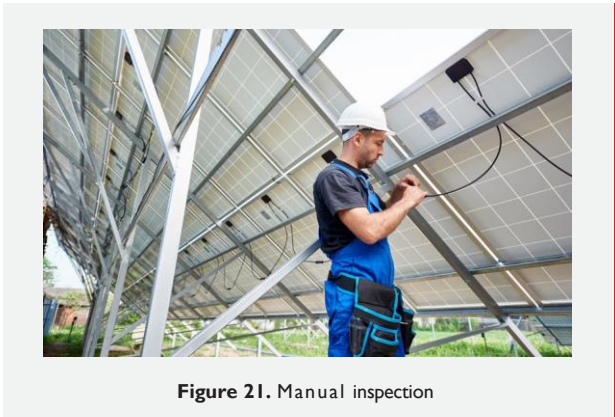

Figure 21. Manual inspection

resistance fault point quickly at the module level with the industry-leading precision of  $\pm 1$  PV module to help owners eliminate potential electric shocks. ■

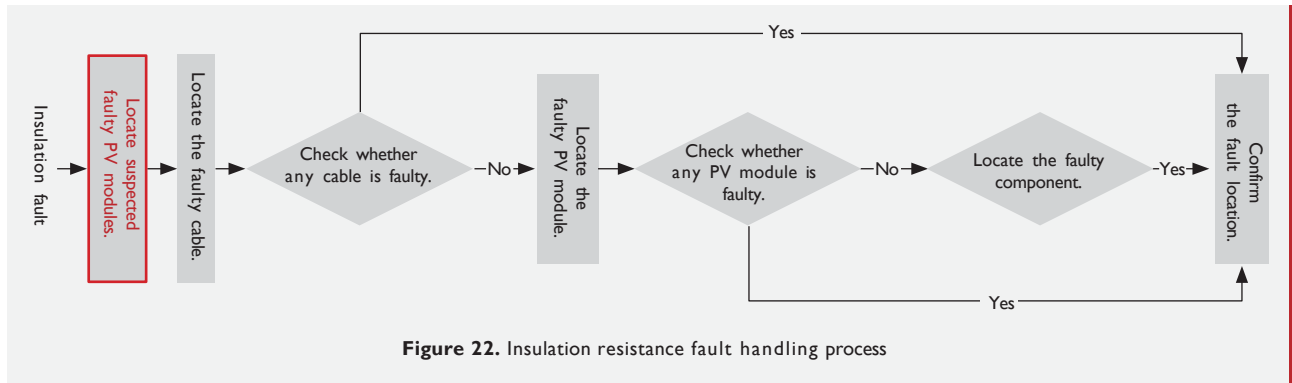

Figure 22. Insulation resistance fault handling process

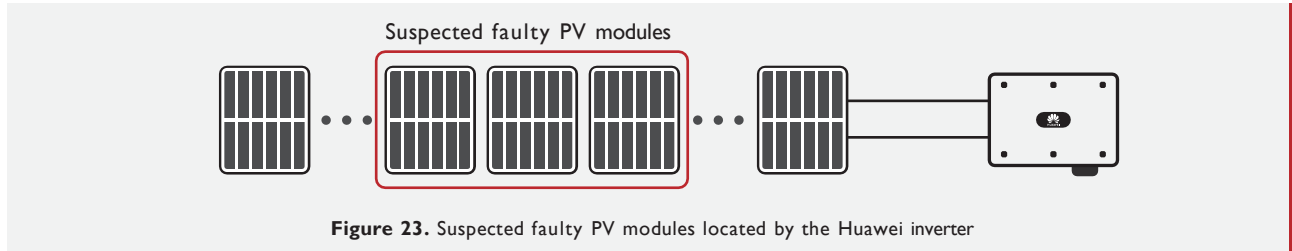

Figure 23. Suspected faulty PV modules located by the Huawei inverter

### 3.5 Summary

Huawei's system-level solution ensures the safety and reliability of PV plants. Huawei provides safety protection technologies to protect equipment, including the SSLD, PV cable-to-ground short-circuit protection, and terminal overtemperature detection. In terms of asset safety, Huawei offers the AFCI and rapid shutdown technologies to prevent fires caused by arcs. In addition, the module-level RSD and module-level insulation impedance fault location technologies are provided to reduce the risk of electric shocks and ensure personal safety. Such system-level solution design and industry-leading safety technologies are the core competitive strengths for Huawei to build safe and reliable C&I PV plants. ■



# FusionSolar C&I PV Safety Test

Safety is the red line of the PV industry. As a mainstream supplier of PV solutions, Huawei always prioritizes the design of safety solutions. In addition, to continuously raise the safety and reliability levels of PV products across the industry, Huawei has always actively contributed to formulating C&I PV safety standards, such as IEC standards, EIT standards in Thailand,

INMETRO standards in Brazil, and GB standards in China. To deeply understand and verify the technical status and performance of Huawei's solutions, a verification team commissioned by Huawei is set up to verify and evaluate the key performance of Huawei's C&I PV solutions from April to May 2023. ■

## 4.1 Function Tests

The empirical tests aim to verify whether Huawei inverters have the claimed capabilities by visual inspection. The test items and objectives are as follows:

SSLD	PV Ground-Fault Protection	AFCI	RSD	Module-level Resist Insulation Detection
To verify that the Huawei SSLD device can automatically disconnect faulty DC circuits in milliseconds.	To verify that Huawei inverters can automatically disconnect faulty circuits when a grounding fault occurs.	To verify that Huawei inverters can automatically shut down arcs within 0.5s when DC arcs occur.	To verify that Huawei inverters can reduce the voltage to below 30 V within 30s when working with Huawei optimizers.	To verify that Huawei inverters can generate shutdown alarms and locate faults when the insulation resistance is lower than the threshold.

### 4.1.1 | Smart String-Level Disconnect (SSLD)

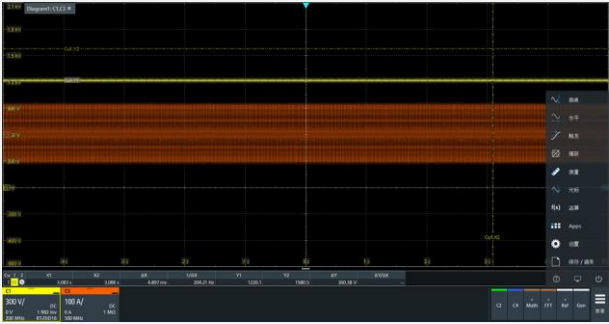
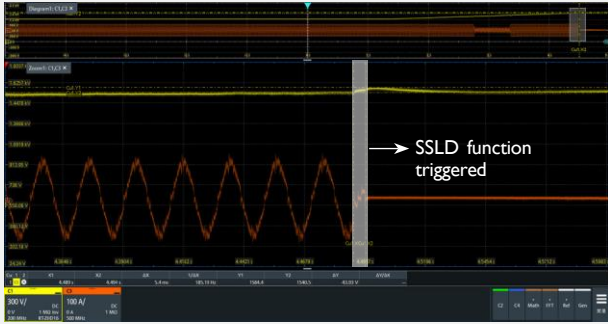

Normal operation

SSLD is triggered

---

<b>Test Objective</b>	To verify that the SSLD device of Huawei inverters has the claimed DC fault disconnection capability.
<b>Test Method</b>	Simulate a DC overvoltage fault on a Huawei inverter to check whether the inverter can disconnect the faulty circuit within 15 ms.
<b>Test Result</b>	According to the test result, Huawei SSLD device can cut off the circuit in about 5 ms, which meets the expectation.

### 4.1.2 | PV Ground-Fault Protection

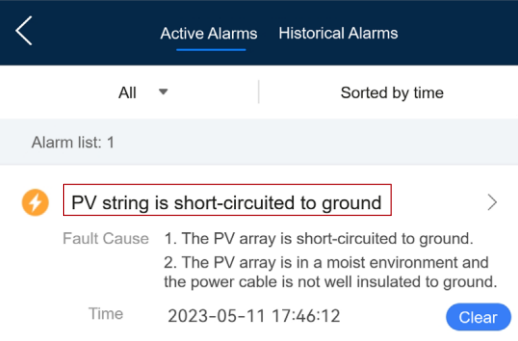
Huawei inverter

Decoupling tooling

Warning on FusionSolar APP

---

<b>Test Objective</b>	To verify that the built-in detection and protection device of Huawei inverters can quickly disconnect PV cable-to-ground short-circuits.
<b>Test Method</b>	Connect a 3-ohm resistor to the ground on the PV side of a Huawei inverter to simulate a short circuit and observe the inverter operation.
<b>Test Result</b>	After a short circuit occurs, the Huawei inverter immediately disconnects the faulty circuit and reports an alarm to the app.

### 4.1.3 | AFCI



Huawei inverter



DC arc generator

**Fault Cause**

The PV string power cable arcs or is in poor contact.

---

**Suggestion**

Recommended: Check that the PV string power cable does not arc and is in good contact. The following is the mapping between PV strings and alarm cause ID1: PV string 1

Warning on FusionSolar APP

**Test Objective** To verify that the DC arc detection and cut-off device in Huawei inverters can rapidly rectify arc faults within 0.5s.

**Test Method** With the input voltage of 320 V DC and input current of 6.5 A, use an arc generator to make a DC arc with the arc gap of 0.9 mm.

**Test Result** The inverter automatically cuts off the arc in about 0.2s.

### 4.1.4 | Module-Level Rapid Shutdown (RSD)

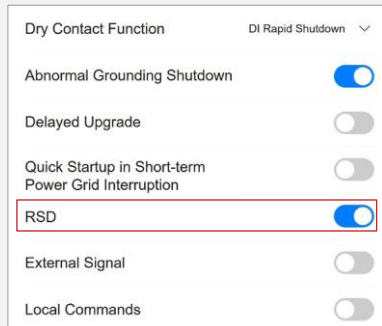

Warning on FusionSolar APP

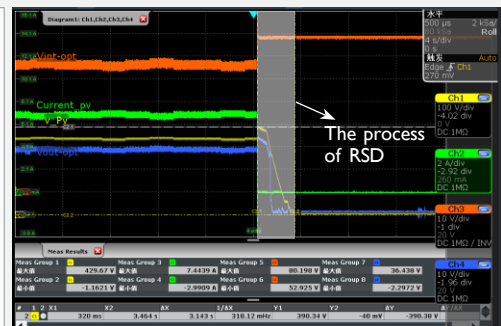

RSD enabled

**Test Objective** To verify that the system voltage can be reduced to 3 V within 30s when Huawei inverters work with Huawei optimizers.

**Test Method** Use a dry contact to trigger a high-voltage fault in a Huawei inverter.

**Test Result** The optimizer disconnects the circuit in about 3s, the voltage decreases from 430 V to less than 30 V, and an alarm is reported to the app.

## 4.1.5 | Module-level Resist Insulation Detection

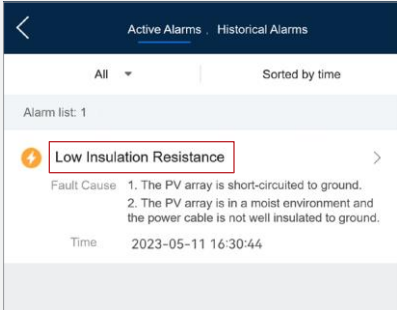
		<p><b>Fault Cause</b></p> <ol style="list-style-type: none"> <li>1. The PV array is short-circuited to ground.</li> <li>2. The PV array is in a moist environment and the power cable is not well insulated to ground.</li> </ol> <p><b>Suggestion</b></p> <ol style="list-style-type: none"> <li>1. Check the impedance between the PV array output and PE. If there is a short circuit or poor insulation point, eliminate it.</li> <li>2. Check that the PE cable of the solar inverter is correctly connected.</li> <li>3. If the impedance is lower than the specified protection threshold on rainy and cloudy days, set Insulation resistance protection using the mobile app, SmartLogger, or NMS.</li> </ol>
Huawei inverter	Warning on FusionSolar APP	Failure analysis
<p><b>Test Objective</b></p>	<p>To verify that Huawei inverters equipped with the insulation resistance detection and fault location device can rapidly disconnect faulty circuits, locate faults, and generate alarms on the app.</p>	
<p><b>Test Method</b></p>	<p>Connect a 1-kilohm resistor to the ground on the PV+ of a Huawei inverter to simulate an insulation fault.</p>	
<p><b>Test Result</b></p>	<p>The inverter successfully cuts off the insulation resistance fault. The app displays the insulation resistance value and locates the fault.</p>	

## 4.2 Summary

Empirical test results on technologies, such as the SSLD, PV Ground-Fault Protection, AFCI, RSD, and module-level resist insulation detection, prove that Huawei inverters are consistent with the claimed excellent performance in safety. Thanks to systematic safety solution design, Huawei inverters can effectively reduce equipment faults on the DC side, prevent electric arc hazards and fires, reduce asset losses, and ensure the safety of firefighters and O&M personnel in emergencies. ■



Safe construction of PV systems is a long-term mission. C&I PV systems require intelligent methods to improve the safety of PV plants and avoid equipment losses, asset losses, and personal injuries. Intelligent safety measures consolidate the foundation for the sustainable development of C&I PV. However, from the perspective of the entire PV industry, the design and application of safety solutions for PV plants have not become a consensus. To achieve high safety and reliability of C&I PV systems, the entire industry needs to work together.



Huawei C&I PV solutions always uphold safety first as the fundamental design principle, and provide comprehensive protection for C&I owners together with industry-leading safety protection technologies. Huawei hopes to work with other industry players to continuously improve C&I PV safety standards, build 100% safe and reliable PV plants, facilitate low-carbon transformation in all walks of life, and build sustainable business. ■



**Copyright © 2023 Huawei Digital Power Technologies Co., Ltd. All rights reserved.**

No part of this document may be reproduced or transmitted in any form or by any means without prior written consent of Huawei Digital Power Technologies Co., Ltd.

#### **Trademark Notice**

 **HUAWEI** and  are trademarks or registered trademarks of Huawei Technologies Co., Ltd. Other trademarks, product, service and company names mentioned are the property of their respective owners.

#### **General Disclaimer**

The information in this document may contain predictive statements including, without limitation, statements regarding the future financial and operating results, future product portfolio, new technology, etc. There are a number of factors that could cause actual results and developments to differ materially from those expressed or implied in the predictive statements. Therefore, such information is provided for reference purpose only and constitutes neither an offer nor an acceptance. Huawei Digital Power Technologies Co., Ltd. may change the information at any time without notice.

#### **HUAWEI DIGITAL POWER TECHNOLOGIES CO., LTD.**

Antuoshan Headquarters Towers, 33 Antuoshan 6th Road, Futian District, Shenzhen, P.R.C.  
solar.huawei.com